

SERIE **XP**

3.1.2.3.

Pompa ad Ingranaggi
Gear Pump

CODICE DI ORDINAZIONE / DECODING

3.1.2.3 . XXX . X . 0 . X . 0

UNI
21-222

ALLESTIMENTI SPECIALI/SPECIAL OPTIONS
0 = NON RICHIESTO/STANDARD OPTION
7 = ASPIRAZIONE LATERALE - MANDATA IN TESTA
SIDE INLET - REAR OUTLET

ROTAZIONE/ROTATION
1 = SINISTRO/ANTICLOCKWISE
2 = DESTRO/CLOCKWISE

CILINDRATA/DISPLACEMENT

CODICE BASE/BASIC CODE

XP 83

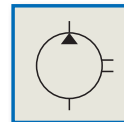

CARATTERISTICHE E DATI TECNICI / SPECIFICATIONS AND TECHNICAL DATA

TIPO TYPE	CODICE CODE	CILINDRATA DISPLACEMENT cm ³ /rev.	A mm	B mm	C	D mm	PESO WEIGHT kg
--------------	----------------	---	---------	---------	---	---------	----------------------

XP 83	3.1.2.3.083.X.0.X.0	83	189	90.5	1" G	116	11.2
-------	---------------------	----	-----	------	------	-----	------

Corredato di: Tappo cod. 0.12.01.108.000 + Rondella cod. 0.04.01.157.000
Included: Plug code 0.12.01.108.000 + Washer code 0.04.01.157.000

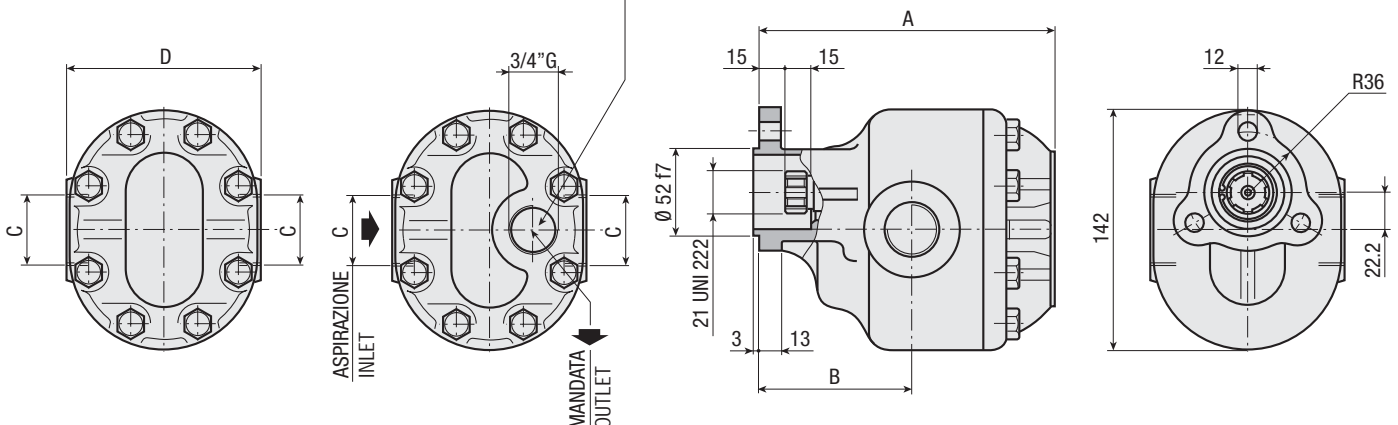

DATI TECNICI / TECHNICAL DATA

ESEMPIO CICLI LAVORO / EXAMPLE OF WORKING CYCLES

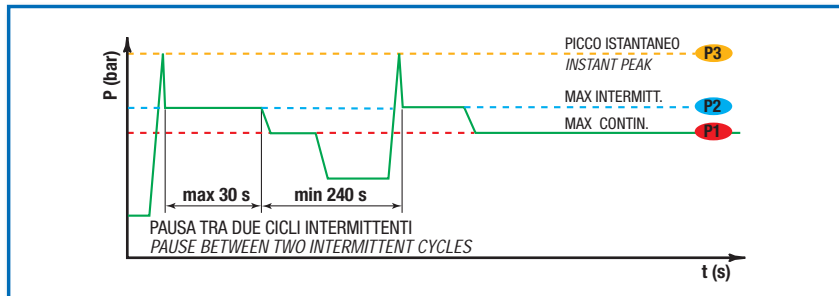

Pressione d'aspirazione: Inlet pressure:	0.7 ÷ 1.5 bar (assoluti/absolute)
Campo viscosità lavoro: Operating viscosity range:	12 ÷ 100 cSt
Temperatura fluido °C (t): Fluid temperature °C (t):	-10° + 80° C

Pressione Lavoro Working Press. P2	Contaminazione / Contamination		Filtro / Filter βx = 75
	NAS 1638	ISO 4406	
≤ 200 bar	12	21/18	40 μm
≥ 200 bar	11	20/17	25 μm

◀ **FILTRAZIONE CONSIGLIATA (ritorno o mandata)**
RECOMMENDED FILTERING (return or outlet)

TIPO / TYPE			XP 83								
Cilindrata Displacement	Vg	cm ³ /n cm ³ /rev.									83
Pressione massima continua Max continuous operating pressure	P1										210
Pressione massima intermittente Max intermitt. operating pressure	(max 30 s) P2	bar									230
Pressione massima di picco Max peak pressure	(≤ 0.1 s) P3										300
Velocità massima intermittente Max intermittent speed	(P ≤ 20 bar) n3										3000
Velocità massima continua Max continuous speed	(≤ P1) n1	n/min r.p.m.									2500
Velocità minima intermittente Min intermittent speed	(≤ P2 x 0.5) (max 30 s) n4										300

POTENZA ASSORBITA / ABSORBED POWER

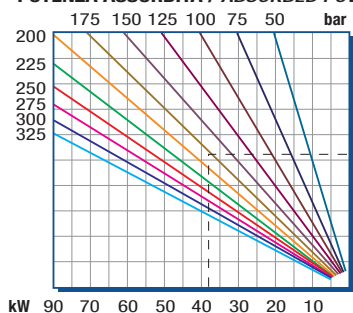

PORTATA / CAPACITY

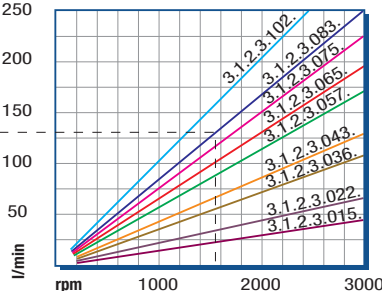

RILIEVI ESEGUITI CON OLIO
ISO VG 46 A 50° C (ν=30 cSt)
THE ABOVE SPECIFICATIONS
REFER TO OIL TYPE ISO
VG 46 AT 50° C (ν=30 cSt)

DIAGRAMMI / DIAGRAMS

RENDIMENTO VOLUMETRICO / VOLUMETRIC EFFICIENCY

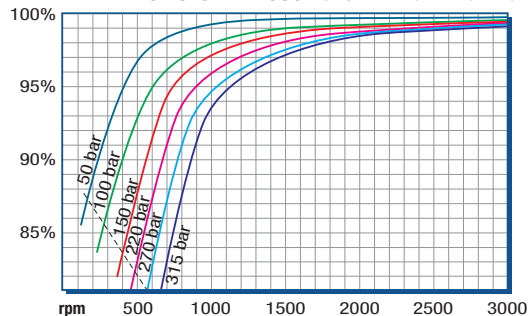

COPPIA ASSORBITA / INPUT TORQUE

